

***Nikon***

**PHOTOMIC FINDER DP-1**

**20FD11**

**REPAIR MANUAL**



**NIPPON KOGAKU K.K.**

Tokyo, Japan

Photomic Finder DP-1CONTENTS

	Page
Illustrations of each parts . . . (Fig. 1 - 5) . . . . .	1 - 5
Electrical Connections . . . . . (Fig. 6) . . . . .	6
Adjustment of the Ready-Light . . (Fig. 7) . . . . .	7
Parts list . . . . .	8 - 28
Subassembly list . . . . .	29 - 30

## NOTE:

Marks in the "Term of Sale" column of the parts list are;

- . . . . . Can be supplied individually
- △ . . . . . Not supplied individually but only as subassembly
- △ . . . . . Supplied either as part or subassembly
- × . . . . . Not considered as repair part

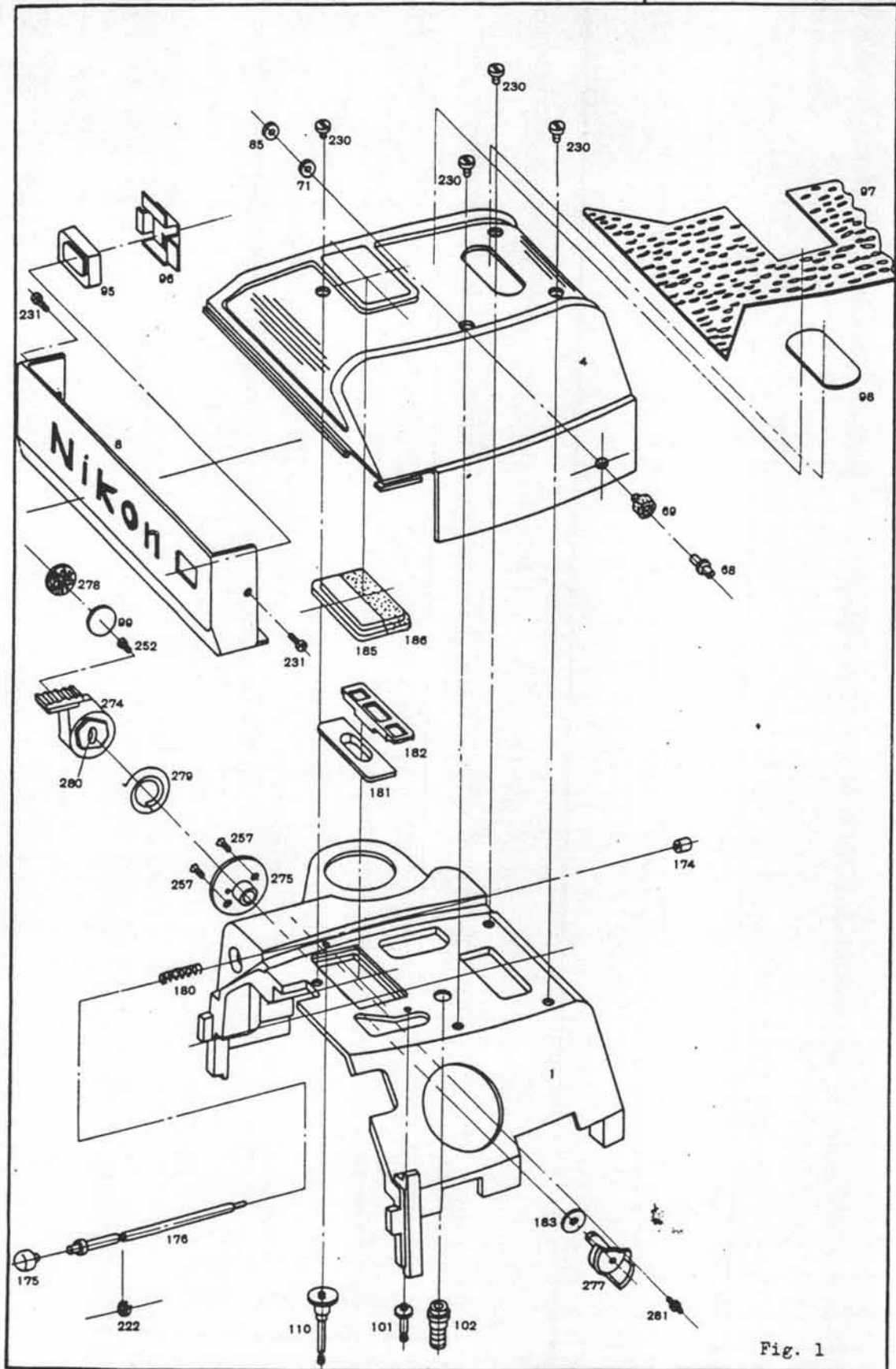

Fig. 1

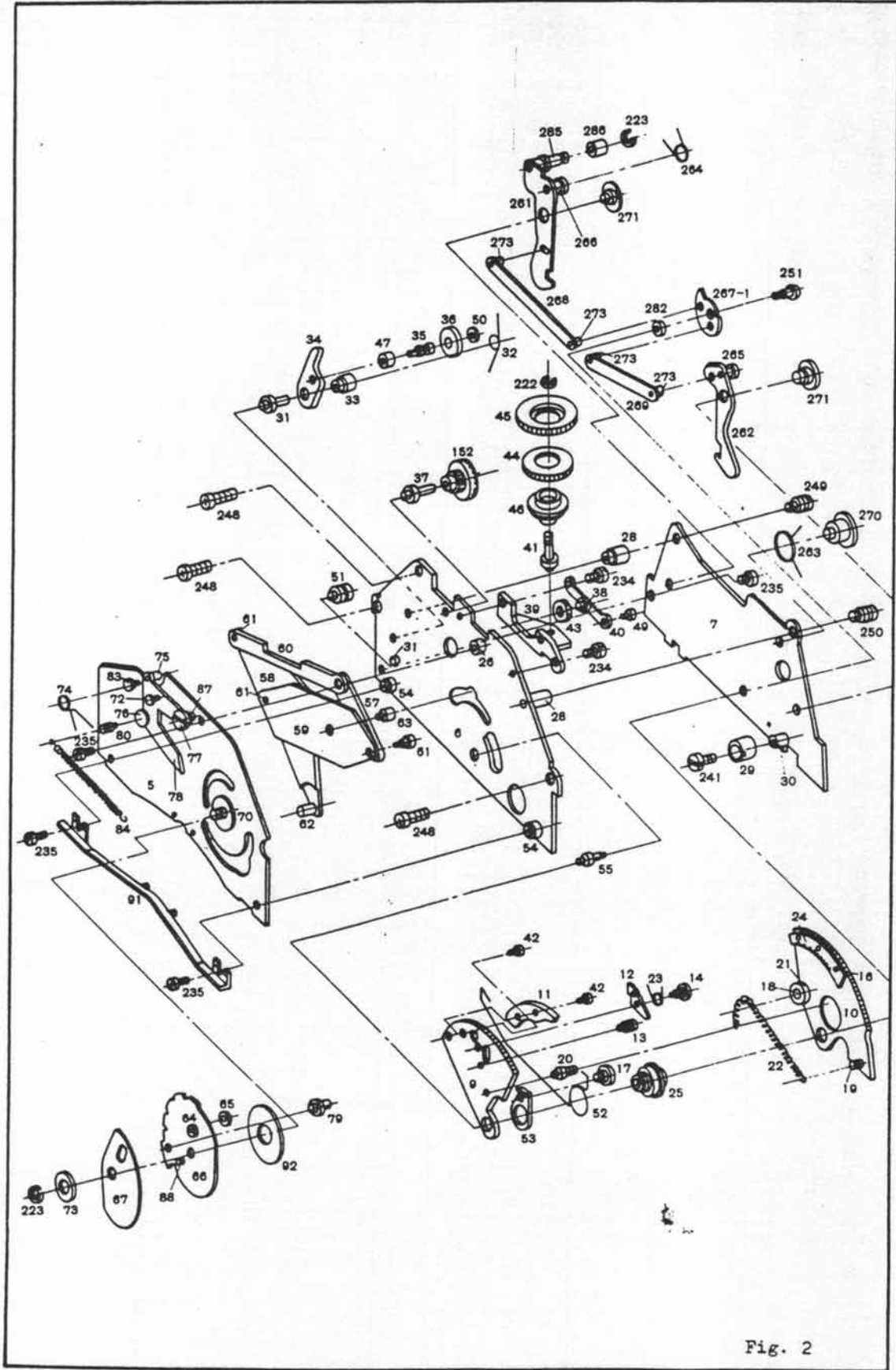

Fig. 2

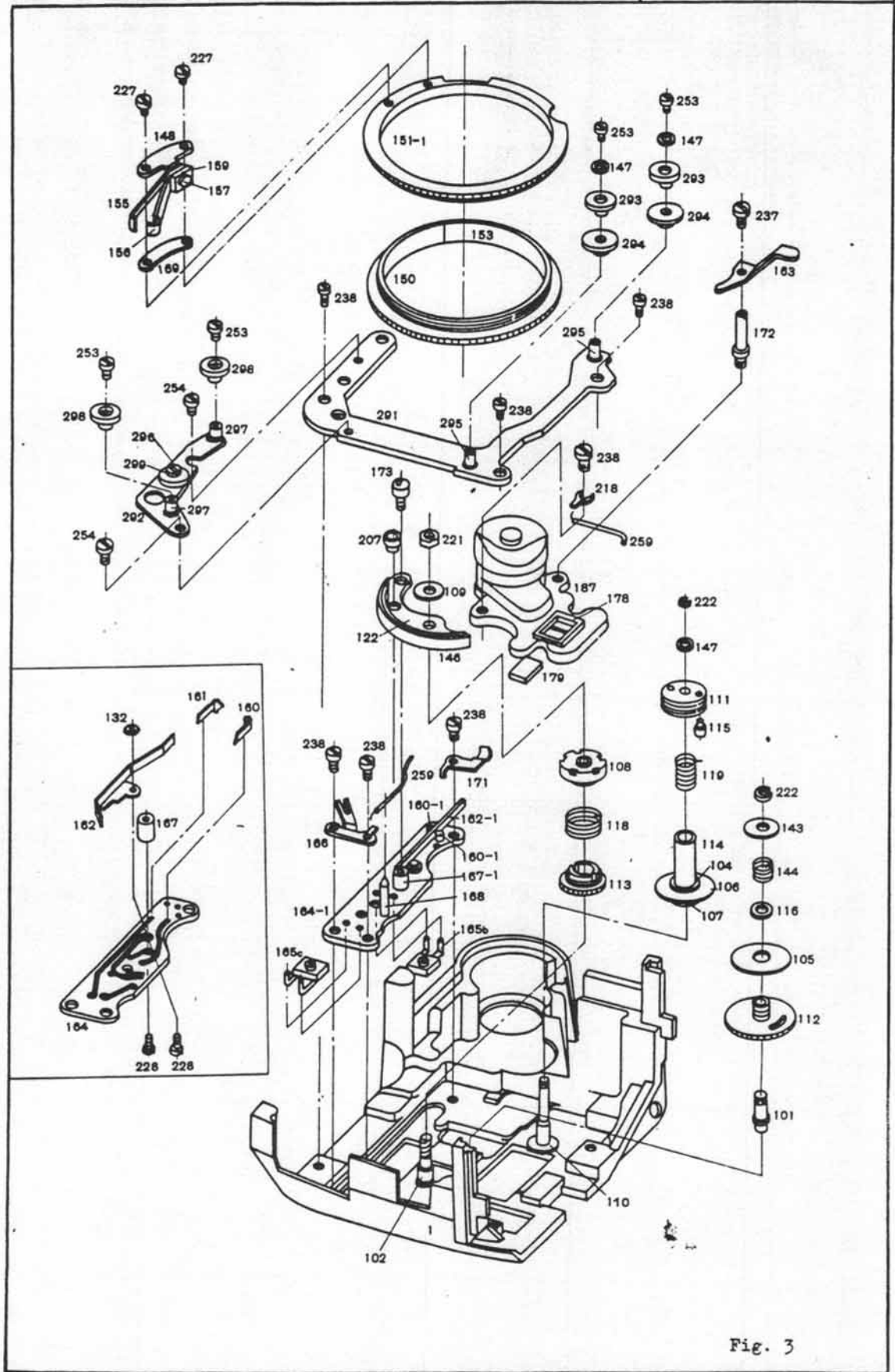

Fig. 3

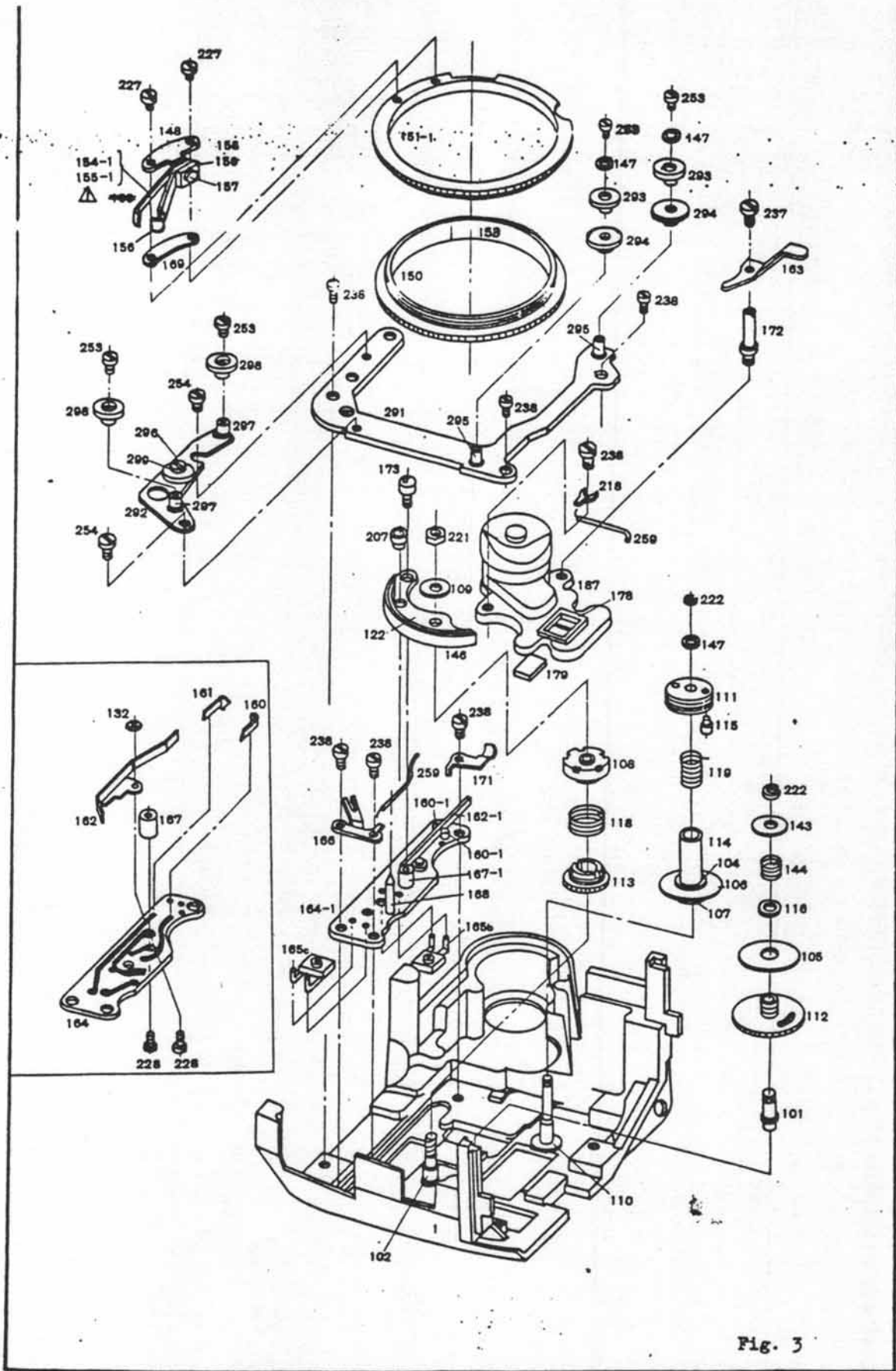

Fig. 3

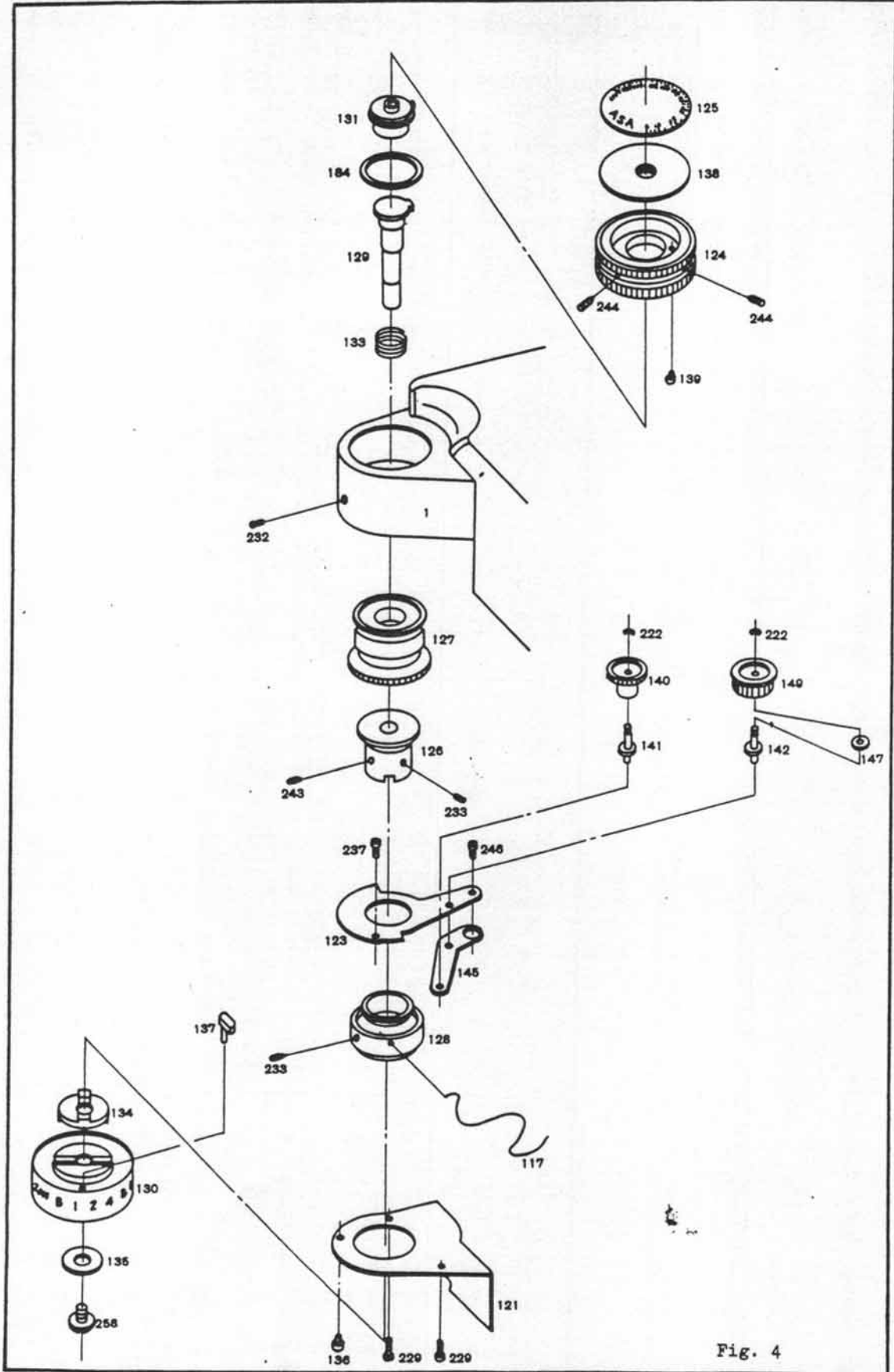
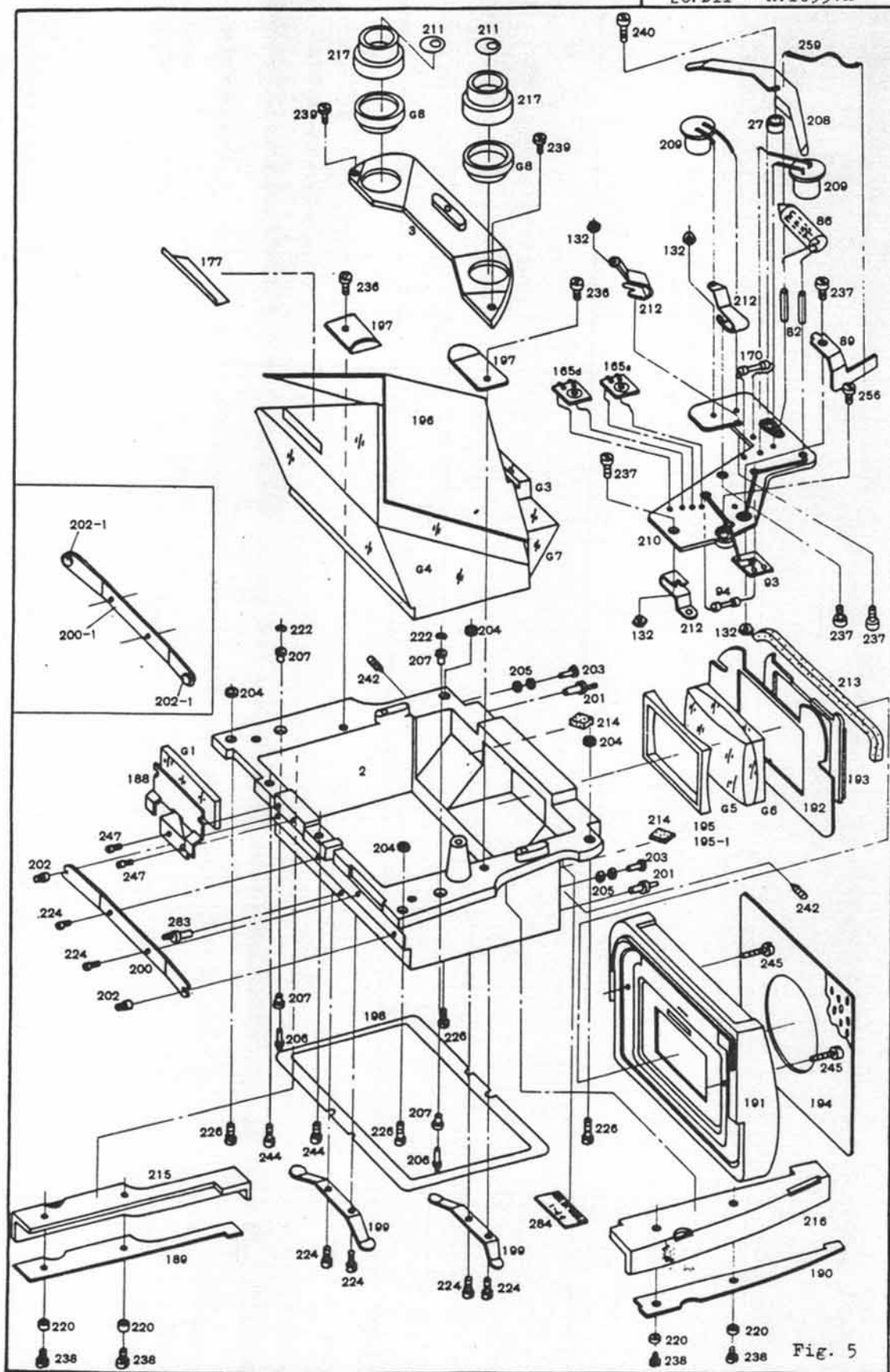

Fig. 4





Electrical Connections

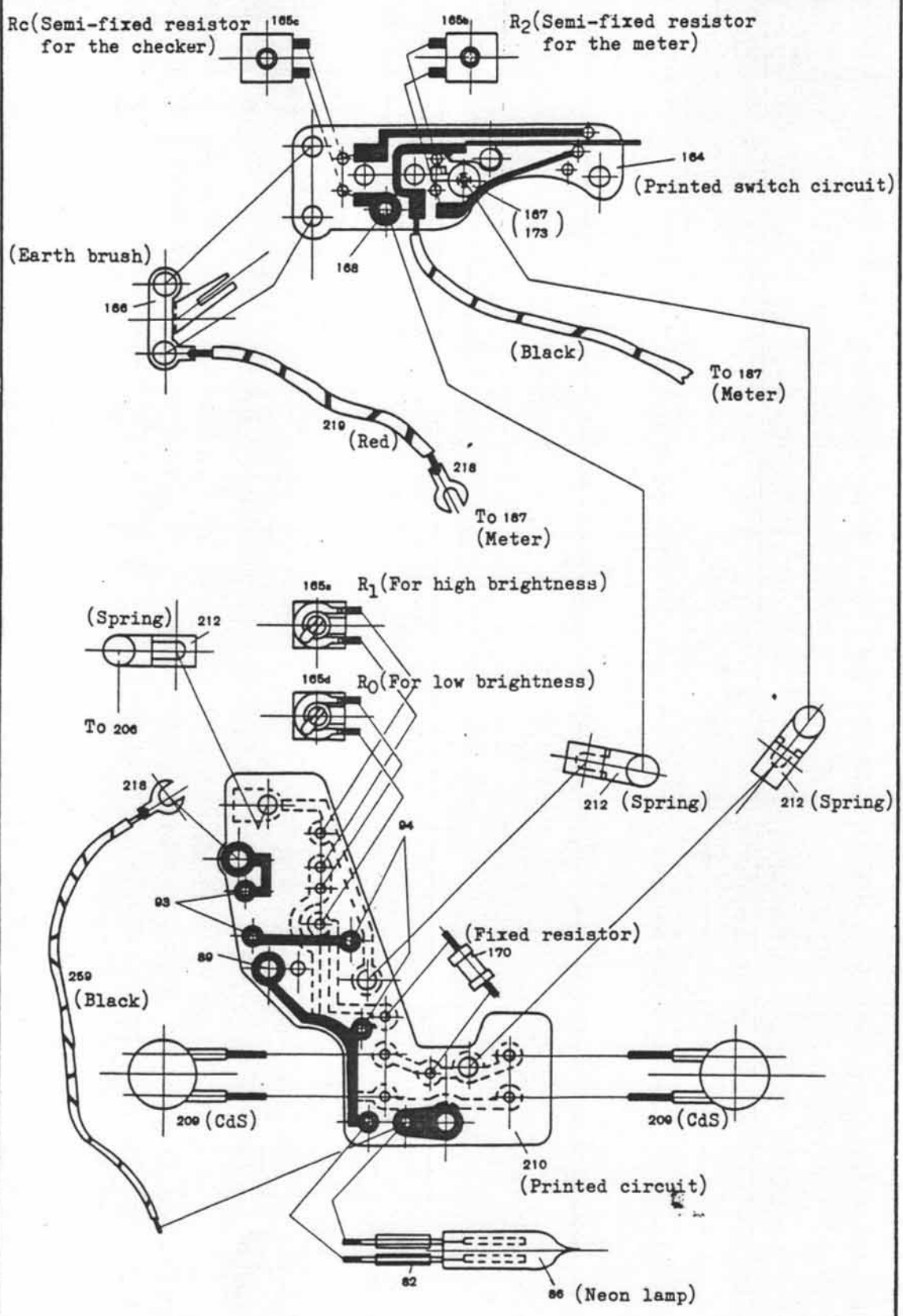
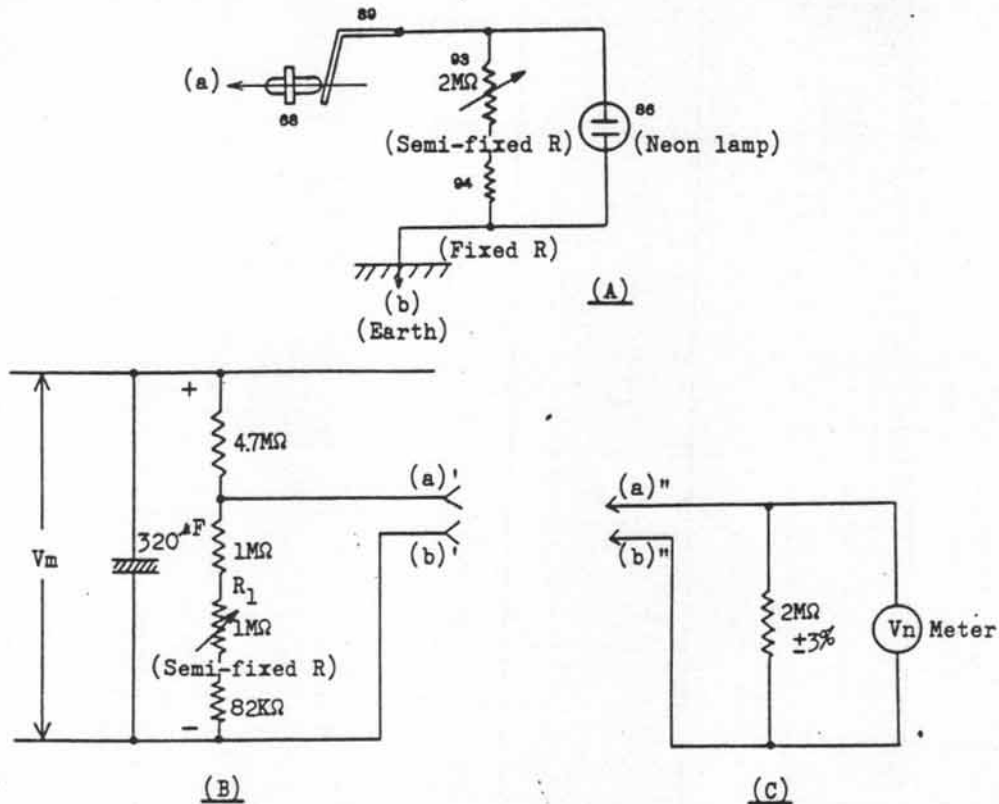

Fig. 6

Adjustment of the Ready-LightAdjustment of lighting voltage for the Neon lamp (#86)

For performing this adjustment, it is necessary to prepare the B-circuits (as tools) and the C-circuit (as a voltmeter), as shown in the above diagrams.

Make a rated power source voltage  $V_m$  of each B-circuit 450V.

Connecting one of the B-circuits to the C-circuit (meter), adjust the semi-fixed resistor  $R_1$  in the B-circuit to have the indication 62V on the C-circuit meter ( $V_n$ ).















Connecting the other B-circuit, make adjustment of the Semi-fixed resistor to have the indication 64V on the C-circuit meter ( $V_n$ ).















Then, adjust the semi-fixed resistor #93 in the main circuit A, so that the neon lamp (#86) does not light, when the main circuit A is connected to the B-circuit with 62V, but the lamp lights positively, when it is connected to the B-circuit with 64V.

As the voltmeter, use a digital type voltmeter with an input impedance of 10 MΩ.

Fig. 7















## Parts list















Part No. 部品番号	Name and Shape 名称および形状	Pcs. per Unit 1台分個数	Reference Subassembly No. 参照部組品番号	Reference Fig. No. 参照図番	Term of Sale 販売区分	Remarks 備考
20FD11-1	Body 	1	A1, A2	1, 3 4	△	
2	Prism box 	1	B1, B2	5	△	
2-1			B1-1, B2-1			
3	CdS holder 	1	C1	5	△	
4	Top cover 	1	D1	1	△	
5	Front plate 	1	A1 E1, E2	2	△	
6	Middle plate 	1	A1 E1, E3	2	△	
7	Rear plate 	1	A1 E1, E4	2	△	
8	Front cover 	1	D2	1	○△	
9	Front segment 	1	A1 E1, E5	2	△	
10	Rear segment 	1	A1 E1, E6	2	△	
11	Segment shoe 	1	A1 E1, E5	2	△	
12	Claw 	1	A1 E1, E5	2	△	
13	Claw spring stud 	1	A1 E1, E5	2	△	
14	Claw axle 	1	A1 E1, E5	2	△	
15						(Blank)





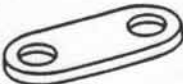











Part No. 部品番号	Name and Shape 名称および形状	Pcs. per Unit 1台分個数	Reference Subassembly No. 参照部組品番号	Reference Fig. No. 参照図番	Term of Sale 販売区分	Remarks 備考
20FD11-16	Segment rivet 	3	A1 E1, E6	2	△	
17	Rocker spring stud B 	1	A1 E1, E5	2	△	
18	Spring drum axle 	1	A1 E1, E6	2	△	
19	Spring stud A 	1	A1 E1, E6	2	△	
20	Spring stud B 	1	A1 E1, E5	2	△	
21	Spring drum 	1	A1 E1, E6	2	△	
22	Segment spring 	1	A1, E1	2	○△	
23	Claw spring 	1	A1 E1, E5	2	○△	
24	Memory ratchet 	1	A1 E1, E6	2	△	
25	Segment axle 	1	A1 E1, E5	2	△	
26	Front plate stand A 	1	A1 E1, E3	2	△	
27	Front plate collar 	1		5	○	
28	Rear plate stand A 	2	A1 E1, E3	2	△	
29	Segment eccentric 	1	A1, E1	2	○△	
30	Segment adjuster 	1	A1 E1, E4	2	△	













\* F-: Represents the "Aperture scale".

20FD11 - R.1033.A









Part No. 部品番号	Name and Shape 名称 および 形状	Pcs. per Unit 1台分個数	Reference Subassembly No. 参照部品番号	Reference Fig. No. 参照図番	Term of Sale 販売区分	Remarks 備考
20FD11-31	Click axle 	1	A1 E1, E3	2	△	
32	Click spring 	1	A1, E1	2	○△	
33	Click axle bearing 	1	A1 E1, E7	2	△	
34	Click lever 	1	A1 E1, E7	2	△	
35	Roller shaft 	1	A1 E1, E7	2	△	
36	Click roller 	1	A1, E1	2	○△	
37	Resistor idle gear shaft 	1	A1 E1, E3	2	△	
* 38	F-idle gear shaft 	1	A1 E1, E8	2	△	
39	Bracket A 	1	A1 E1, E8	2	△	
40	Bracket B 	1	A1 E1, E8	2	△	
41	F-gear shaft 	1	A1 E1, E8	2	△	
42	Shoe rivet 	2	A1 E1, E5	2	△	
43	F-idle gear 	1	A1, E1	2	○△	
44	F-gear A 	1	A1 E1, E9	2	△	
45	F-gear B 	1	A1 E1, E9	2	△	

Part No. 部品番号	Name and Shape 名称 および 形状	Pcs. per Unit 1台分個数	Reference Subassembly No. 参照部品番号	Reference Fig. No. 参照図番	Term of Sale 販売区分	Remarks 備考
20FD11-46	F-gear boss 	1	A1 E1, E9	2	△	
47	Roller collar 	1	A1 E1, E7	2	△	
48	Pantograph stopper 	1	A1 E1, E3	2	△	
49	Bracket pin 	1	A1 E1, E8	2	△	
50	Click roller washer 	1	A1, E1	2	○△	
51	Rear plate stand 	1	A1 E1, E3	2	△	
52	Rocker spring 	1	A1, E1	2	○△	
53	Rocker 	1	A1 E1, E5	2	△	
54	Front plate stand B 	2	A1 E1, E3	2	△	
55	Rear plate stand C 	1	A1 E1, E3	2	△	
56						(Blank)
57	Pantograph D 	1	A1 E1, E10	2	△	
58	Pantograph A 	1	A1 E1, E10	2	△	
59	Pantograph B 	1	A1 E1, E10	2	△	
60	Pantograph C 	1	A1 E1, E10	2	△	

Part No. 部品番号	Name and Shape 名称 及び 形状	Pcs. per Unit 1台分個数	Reference Subassembly No. 参照部品番号	Reference Fig. No. 参照図番	Term of Sale 販売区分	Remarks 備考
20FD11-61	Pantograph pin 	3	A1 E1, E10	2	△	
62	Diaphragm coupling pin 	1	A1 E1, E10	2	△	
63	Pantograph long pin 	1	A1	2	△	
63-1	Pantograph long pin 		E1, E10			
64	Max. aperture scale eccentric 	1	A1 E1, E11	2	△	
65	Washer 	1	A1 E1, E11	2	△	
66	Max. aperture ratchet 	1	A1 E1, E11	2	△	
67	Max. aperture scale 	1	A1, E1	2	○△	
68	Terminal 	1	D1	1, 7	△	
69	Terminal 	1	D1	1	△	
70	Max. aperture scale axle 	1	A1 E1, E2	2	△	
71	Insulating washer 	1	D1	1	△	
72	Claw spring stud 	1	A1 E1, E2	2	△	
73	Washer 	1	A1, E1	2	○△	
74	Ratchet spring 	1	A1, E1	2	○△	
75	Pantograph adjuster 	1	A1 E1, E2	2	△	















Part No. 部品番号	Name and Shape 名称および形状	Pcs. per Unit 1台分個数	Reference Subassembly No. 参照部品番号	Reference Fig. No. 参照図番	Term of Sale 販売区分	Remarks 備考
20FD11-76	Ratchet claw stopper pin 	1	A1 E1, E2	2	△	
77	Max. aperture ratchet claw axle 	1	A1 E1, E2	2	△	
78	Ratchet claw 	1	A1 E1, E2	2	△	
79	Max. aperture ratchet pin 	1	A1 E1, E11	2	△	
80	Spring stud A 	1	A1 E1, E2	2	△	
81						(Blank)
82	Insulating tube 	2	F1	5, 6	○△	
83	Ratchet spring pin 	1	A1 E1, E2	2	△	
84	Max. aperture spring 	1	A1, E1	2	○△	
85	Washer 	1	D1	1	△	
86	Neon lamp 	1	F1	5, 6 7	○△	Equivalent to 20FA25F #6, 20FD10 #38
87	Washer 	1	A1 E1, E2	2	△	
88	Spring stud 	1	A1 E1, E11	2	△	
89	Spring contact 	1	F1	5, 6 7	○△	
90						(Blank)



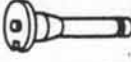

















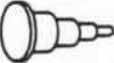







Part No. 部品番号	Name and Shape 名称 および 形状	Pcs. per Unit 1台分個数	Reference Subassembly No. 参照部組品番号	Reference Fig. No. 参照図番	Term of Sale 販売区分	Remarks 備考
20FD11-91	Front dust cover 	1	A1, E1	2	○△	
92	Washer 	1	A1, E1	2	○△	
93	Semi-fixed resistor 	1	F1	5, 6 7	○△	Equivalent to 20FD10 #39
94	Fixed resistor 	1	F1	5, 6 7	○△	Equivalent to 20FD10 #40
95	Max. aperture scale window 	1	D2	1	○△	
96	Window frame 	1	D2	1	○△	
97	Top cover leatherette 	1		1	○	
98	Hole cover 	1		1	○	
99	Hole cover 	1	A1, A2	1	○△	
100						(Blank)

















\* T-: Represents the "Shutter speed."













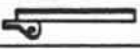





20FD11 - R.1033.A

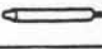



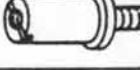









Part No. 部品番号	Name and Shape 名称および形状	Pcs. per Unit 1台分個数	Reference Subassembly No. 参照部組品番号	Reference Fig. No. 参照図番	Term of Sale 販売区分	Remarks 備考
20FD11-101	F-film shaft 	1	A1, A2	1, 3	△	
102	F-film spring holder 	1	A1, A2	1, 3	△	
103						(Blank)
* 104	T-film washer 	1	A1, A2 T1	3	△	
105	Aperture scale dial (film) 	1	A1, A2	3	○△	
106	Shutter speed scale dial (film) 	1	A1, A2 T1	3	△	
107	T-film washer 	1	A1, A2 T1	3	△	
108	T-film spring mount 	1	A1, A2	3	○△	
109	F-film washer 	1	A1, A2	3	○△	
110	T-film shaft 	1	A1, A2	1, 3	△	
111	T-film pulley 	1	A1, A2 T2, T3	3	△	
112	F-film gear 	1	A1, A2	3	○△	
113	F-film spring gear 	1	A1, A2	3	○△	
114	F-film boss 	1	A1, A2 T1	3	△	
115	T-pulley pin 	1	A1, A2 T2, T3	3	△	





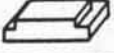













Part No. 部品番号	Name and Shape 名称 および 形状	Pcs. per Unit 1台分個数	Reference Subassembly No. 参照部組品番号	Reference Fig. No. 参照図番	Term of Sale 販売区分	Remarks 備考
20FD11-116	F-film washer 	1	A1, A2	3	○△	
117	Thread	1	A1, A2 T2	4	○△	
118	F-film spring 	1	A1, A2	3	○△	
119	F-film spring 	1	A1, A2	3	○△	
120						(Blank)
121	T-bottom cover 	1	A1, A2 T4	4	△	
122	Common contact base 	1	A1, A2 H1	3	△	
123	Racket plate 	1	A1, A2 T5	4	△	
124	ASA dial knob 	1	A1, A2 T6	4	△	
125	ASA dial 	1	A1, A2 T6	4	○△	
126	Clutch 	1	A1, A2	4	○△	
127	Clutch gear 	1	A1, A2	4	○△	
128	T-drum 	1	A1, A2 T2	4	○△	
129	T-dial shaft 	1	A1, A2	4	○△	
130	Shutter speed dial 	1	A1, A2 T7	4	△	

Part No. 部品番号	Name and Shape 名称および形状	Pcs. per Unit 1台分個数	Reference Subassembly No. 参照部品組品番号	Reference Fig. No. 参照図番	Term of Sale 販売区分	Remarks 備考
20FD11-131	ASA dial stopper 	1	A1, A2 T6	4	△	
132	Nut 	5	F1	3, 5	○△	
133	Clutch spring 	1	A1, A2	4	○△	
134	Coupling ring 	1	A1, A2	4	○△	
135	Washer 	1	A1, A2	4	○△	
136	T-stopper pin A 	1	A1, A2 T4	4	△	
137	T-stopper pin B 	1	A1, A2 T7	4	△	
138	ASA dial base plate 	1	A1, A2 T6	4	△	
139	ASA stopper pin 	1	A1, A2 T6	4	△	
140	T-3rd gear 	1	A1, A2	4	○△	
141	T-gear shaft A 	1	A1, A2 T5	4	△	
142	T-gear shaft B 	1	A1, A2 T5	4	△	
143	F-film gear washer 	1	A1, A2	3	○△	
144	F-film spring 	1	A1, A2	3	○△	
145	T-gear adjuster 	1	A1, A2 T5	4	△	















Part No. 部品番号	Name and Shape 名称 および 形状	Pcs. per Unit 1台分個数	Reference Subassembly No. 参照部品組番号	Reference Fig. No. 参照図番	Term of Sale 販売区分	Remarks 備考
20FD11-146	Common contact piece 	1	A1, A2 H1	3	△	
147	Washer 	4	A1, A2 H3	3, 4	○△	
148	Brush bracket 	1	A1, A2 H2	3	△	
149	T-2nd gear 	1	A1, A2	4	○	
150	Resistor gear 	1	A1, A2 H3, H5	3	△	
151	Brush gear (Has a step) 	1	A1, A2, A3	3	×	
151-1	Brush gear (No step) 	1	A1, A2, A3	3	○△	
152	Resistor gear pinion 	1	A1	2	○△	
153	Resistor 	1	A1, A2 H3, H5	3	△	
154						(Blank)
155	Resistor brush 	1	A1, A2 H2	3	△	
156	Brush C 	1	A1, A2	3	△	
157	Brush rivet 	1	A1, A2 H2	3	△	
158	Insulating washer 	2	A1, A2 H2		△	
159	Brush insulating 	1	A1, A2 H2	3	△	
160	Switch contact A 	1		3	○	
160-1	Switch contact A & B 	2	A1, A2, F2-1	3	△	















Part No. 部品番号	Name and Shape 名称および形状	Pcs. per Unit 1台分個数	Reference Subassembly No. 参照部組品番号	Reference Fig. No. 参照図番	Term of Sale 販売区分	Remarks 備考
20FD11-161	Switch contact B 	1		3	○	
161-1	Rivet 	1	A1, A2, F2-1		△	
162	Switch lead 	1		3	○	
162-1	Switch lead 	1	A1, A2, F2-1	3	△	
163	Earth contact 	1	A1, A2	3	○△	
164	Printed switch 	1		3, 6		
164-1	Printed switch 	1	A1, A2, F2-1	3	△	
165a	Semi-fixed resistor 	1	F1	5, 6	○△	
165b			A1, A2, F2-1	3, 6	○△	
165c			A1, A2, F2-1	3, 6	○△	
165d			F1	5, 6	○△	
166	Earth brush 	1	A1, A2	3, 6	○△	
167	Contact stand 	1		3, 6	○	
167-1	Contact stand 	1	F2-1	3	△	
168	Contact pin 	1	A1, A2 F2-1	3, 6	○△	
169	Brush bracket liner 	1	A1, A2	3	○△	
170	Fixed resistor 	1	F1	5, 6	○△	
171	Switch guide 	1	A1, A2	3	○△	
172	Meter stand 	1	A1, A2	3	○△	
173	Screw 	1	A1, A2	3, 6	○△	
174	Switch collar 	1	A1, A2	1	○△	
175	Switch button 	1	A1, A2 H4	1	△	















Part No. 部品番号	Name and Shape 名称および形状	Pcs. per Unit 1台分個数	Reference Subassembly No. 参照部組品番号	Reference Fig. No. 参照図番	Term of Sale 販売区分	Remarks 備考
20FD11- 176	Switch rod 	1	A1, A2 H4	1	△	
177	Light baffle plate 	1		5	○	
178	Meter needle cover 	1	A1, A2, H8	3	○△	
179	Meter needle cover 	1	A1, A2, H8	3	○△	
180	Switch spring 	1	A1, A2	1	○△	
181	Window frame A 	1	A1, A2	1	○△	
182	Window frame B 	1	A1, A2	1	○△	
183	Washer 	1	A1, A2	1	○△	
184	Washer 	1	A1, A2	4	○△	
185	Window plate (clear) 	1	D1	1	○△	
186	Window plate (opal) 	1	D1	1	○△	
187	Meter 	1	A1, A2 H8	3, 6	△	
188	Mirror holder 	1	C2	5	○△	
189	Side cover holder A 	1		5	○	
190	Side cover holder B 	1		5	○	















Part No. 部品番号	Name and Shape 名称および形状	Pcs. per Unit 1台分個数	Reference Subassembly No. 参照部組品番号	Reference Fig. No. 参照図番	Term of Sale 販売区分	Remarks 備考
20FD11-191	Eyepiece lens case 	1	M1	5	△	
191A	Eyepiece ring 	1	M1		△	
192	Eyepiece mask 	1		5	○	
193	Lens frame 	1		5	○	
194	Eyepiece leatherette 	1		5	○	
195	Eyepiece spacer (pressed) 	1		5	X	
195-1	Eyepiece spacer (molded) 	1		5	○	
196	Prism cover 	1		5	○	
197	Prism retainer 	2		5	○	
198	Aperture mask 	1	B1 B1-1	5	○△	
199	Bottom plate spring 	2	B1 B1-1	5	○△	Equivalent to 20FD9 #18, 20FD10 #4
200	Front side spring 	1	B1	5	○△	For new type die-casting
200-1	Front side spring 	1	B1-1, B3	5	△	
201	Lock pin 	2	B1, B1-1 B2, B2-1	5	△	
202	Front attaching button 	2	B1	5	○△	
202-1	Front attaching button 	2	B1-1, B3	5	△	
203	Rear attaching button 	2	B1, B1-1	5	○△	
204	Washer 	4		5	○	





























Part No. 部品番号	Name and Shape 名称および形状	Pcs. per Unit 1台分個数	Reference Subassembly No. 参照部組品番号	Reference Fig. No. 参照図番	Term of Sale 販売区分	Remarks 備考
205	Washer 	5	B1, B1-1	5	○△	
206	Contact pin 	2	B1, B1-1	5, 6	○△	
207	Insulating bush 	5	B1, B1-1 B2, B2-1 H1	3, 5	○△	
208	CdS retainer 	1		5	○	
209	CdS 	2	F1	5, 6	○△	
210	Printed circuit 	1	F	5, 6	△	
211	Diaphragm 	2	C1	5	○△	
212	Contact 	3	F1	5, 6	○△	
213	Sponge A 	1		5	○	
214	Sponge B 	2	B1, B1-1 B2, B2-1	5	○△	
215	Prism side cushion A 	1		5	○	
216	Prism side cushion B 	1		5	○	
217	CdS holder 	2	C1	5	△	
218	Lug 	2	A1, A2	3, 6	○△	Equivalent to 20FD9 #84
219	Lead wire 	1	A1, A2	6	○△	







Part No. 部品番号	Name and Shape 名称および形状	Pcs. per Unit 1台分個数	Reference Subassembly No. 参照部品番号	Reference Fig. No. 参照図番	Term of Sale 販売区分	Remarks 備考
20FD11- 220	Collar 	4		5	○	
221	Nut (2N - 1.6) 	1	A1, A2	3	○△	
222	C clip A (E - 10) 	8	A1, A2 B1, B1-1 E1	1, 2 3, 4 5	○△	
223	C clip B (E - 13) 	2	A1 E1, E4	2	○△	
224	Screw (1.4R - 2 special) 	6	B1, B1-1	5	○△	Equivalent to 20FD9 #180, 20FD10 #9
225						(Blank)
226	Screw (1.7R - 4 special) 	4		5	○	
227	Screw (1.7R - 1.2 special) 	2	A1, A2	3	○△	
228	Screw (1.7R - 2.5 special) 	2		3	○△	
229	Screw [(45°) 1.7Q - 3] 	2	A1, A2	4	○△	
230	Screw (1.7R - 2 special) 	4		1	○	
231	Screw (1.7T - 2.2 special) 	2		1	○	
232a 232b 232c	Screw [(45°) 1.7P - 2.2] 	1		4	○	
233	Screw (1.7U - 2) 	2	A1, A2	4	○△	
234	Screw (1.4R - 2 special) 	2	A1, E1	2	○△	

Part No. 部品番号	Name and Shape 名称および形状	Pcs. per Unit 1台分個数	Reference Subassembly No. 参照部組品番号	Reference Fig. No. 参照図番	Term of Sale 販売区分	Remarks 備考
20FD11-235	Screw (⊕ 1.4R - 2.5) 	4	A1, E1	2	○△	
236	Screw (1.7R - 2) 	2		5	○	
237	Screw (1.7R - 2.5) 	6	A1, A2 F1	3, 4 5	○△	
238	Screw (1.7R - 3 special) 	11	A1, A2	3, 5	○△	
239	Screw (1.7R - 4) 	2		5	○	
240	Screw (⊕ 2R - 6) 	1		5	○	
241	Screw (1.4R - 2.2 special) 	1	A1, E1	2	○△	
242	Set screw (1.4US - 2.5) 	2	B1, B1-1	5	○△	
243	Set screw (1.7US - 2.5) 	1	A1, A2	4	○△	
244	Set screw (1.7US - 3.5) 	5	A1, A2	4, 5	○△	
245	Screw (1.7R - 5.5) 	2		5	○	
246	Screw (1.7R - 3 special) 	1	A1, A2	4	○△	
247	Screw (1.4R - 2.3 special) 	2		5	○	
248	Screw (⊕ 1.7R - 4) 	3	A1	2	○△	
249	Rear plate screw C 	1	A1, E1	2	○△	

Part No. 部品番号	Name and Shape 名称および形状	Pcs. per Unit 1台分個数	Reference Subassembly No. 参照部組品番号	Reference Fig. No. 参照図番	Term of Sale 販売区分	Remarks 備考
20FD11- 250	Rear plate screw A 	1	A1, E1	2	○△	
251	Rear plate screw B 	1	A1, E1	2	○△	
252	Screw (1.7R - 3 special) 	1	A1, A2	1	○△	
253	Screw (1.7R - 1.5 special) 	4	A1, A2 H3	3	○△	
254	Screw (1.7R - 1.8 special) 	2	A1, A2 H3	3	○△	
255						(Blank)
256	Screw (1.7R - 3 special) 	1		5	○	
257	Screw (1.7Q - 2.5 special) 	2	A1, A2	1	○△	
258	Screw (1.7T - 3 special) 	1	A1, A2	4	○△	
259	Lead wire 	1	F1	3, 5 6	○△	
260						(Blank)
261	Hook A 	1	A1 E1, E4	2	△	
262	Hook B 	1	A1 E1, E4	2	△	
263	Hook B spring 	1	A1, E1	2	○△	
264	Hook A spring 	1	A1, E1	2	○△	
265	Hook spring stud 	1	A1 E1, E4	2	△	

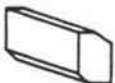
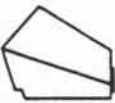
Part No. 部品番号	Name and Shape 名称および形状	Pcs. per Unit 1台分個数	Reference Subassembly No. 参照部組品番号	Reference Fig. No. 参照図番	Term of Sale 販売区分	Remarks 備考
20FD11- 266	Spring holder A 	1	A1 E1, E4	2	○△	
267	Lock link joint 	1	A1, E1	2	○△	
268	Link A 	1	A1 E1, E12	2	△	
269	Link B 	1	A1 E1, E13	2	△	
270	Hook spring axle B 	1	A1 E1, E4	2	△	
271	Hook axle 	2	A1 E1, E4	2	△	
272						(Blank)
273	Link joint pin 	4	A1, E1 E12, E13	2	△	
274	Release lever knob 	1	A1, A2 M2	1	△	
275	Release lever bearing 	1	A1, A2	1	○△	
276						(Blank)
277	Release lever cam 	1	A1, A2	1	○△	
278	Release lever leatherette 	1	A1, A2	1	○△	
279	Release lever spring 	1	A1, A2	1	○△	
280	Release lever knob insert 	1	A1, A2 M2	1	△	

Part No. 部品番号	Name and Shape 名称および形状	Pcs. per Unit 1台分個数	Reference Subassembly No. 参照部組品番号	Reference Fig. No. 参照図番	Term of Sale 販売区分	Remarks 備考
20FD11- 281	Release lever stopper 	1	A1, A2	1	△	
282	Washer 	1	A1, E1	2	○△	
283	Finder locating pin 	1	B1, B1-1 B2, B2-1	5	△	
284	Name plate 	1		5	×	
285	Hook collar shaft 	1	A1 E1, E4	2	△	
286	Collar 	1	A1 E1, E4	2	○△	
287 288 289 290						(Blank)
291	Roller base plate 	1	A1, A2 H3, H6	3	△	
292	Roller adjusting plate 	1	A1, A2 H3, H7	3	△	
293	Brush gear roller 	2	A1, A2 H3	3	○△	
294	Resister gear roller 	2	A1, A2 H3	3	○△	
295	Roller shaft A 	2	A1, A2 H3, H6	3	△	
296	Roller shaft B 	1	A1, A2 H3, H7	3	△	
297	Roller shaft C 	2	A1, A2 H3, H6	3	△	
298	Brush gear adjusting roller 	2	A1, A2 H3	3	○△	

Part No. 部品番号	Name and Shape 名称 および 形状	Pcs. per Unit 1台分個数	Reference Subassembly No. 参照部組品番号	Reference Fig. No. 参照図番	Term of Sale 販売区分	Remarks 備考
20FD11- 299	Resister gear roller 	1	A1, A2 H3, H7	3	△	
300						(Blank)
G1	Mirror 	1	C2	5	○△	
G2						(Blank)
G3	Parallelogram prism 	1	C3	5	△	
G4	Pentagonal prism 	1	C3	5	△	
G5	Eyepiece lens (convex) 	1	C4	5	△	
G6	Eyepiece lens (concave) 	1	C4	5	△	
G7	Light acceptance prism 	2	C3	5	△	
G8	Light acceptance lens 	2	C1	5	○△	

## Subassembly list

20FD11 - R.1033.A

No. of Subassembly	Name	Pcs. per Unit	No. of Constituent Parts (*: Main parts)	Ref. Fig. No.	Remarks
20FD11-A1	Body and meter mechanism	1	Except subassemblies B1, C1, C2, C3, C4, D1, D2, F1 and M1 from the full assembly (20FD11).		
A2	Body	1	Except subassembly E1 and 152 from subassembly A1.		
B1	Prism box and holders	1	*2, 198, 199x2, 200, 201x2, 202x2, 203x2, 205x2, 206x2, 207x4, 214x2, 222x2, 224x6, 242x2, 283	5	
B1-1	Prism box and holders	1	*2-1, 198, 199x2, 200-1, 201-1x2, 202x2, 203x2, 205x2, 206x2, 207x4, 214x2, 222x2, 224x6, 242x2, 283	5	
B2	Prism box	1	*2, 201x2, 207x4, 214x2	5	
B2-1	Prism box	1	*2-1, 201x2, 207x4, 214x2	5	
B3	Front side spring	1	*200-1, 202-1x2	5	
C1	CdS holder	1	*3, 211x2, 217x2, G8x2	5	
C2	Mirror	1	*188, G1	5	
C3	Pentagonal prism	1	*G4, G3, G7x2	5	
C4	Eyepiece lens	1	*G5, G6	5	
D1	Top cover	1	*4, 68, 69, 71, 85, 185, 186	1	
D2	Front cover	1	*8, 95, 96	1	
E1	Pantograph ratchet	1	*E3, E2 - E13, 22, 29, 32, 36, 43, 50, 52, 67, 73, 74, 84, 91, 92, 222, 223x2, 234x2, 235x4, 241, 249, 250, 251-1, 264, 267-1, 282, 286	2	
E2	Front plate	1	*5, 70, 72, 75, 76, 77, 78, 80, 83, 87	2	
E3	Middle plate	1	*6, 26, 28x2, 31, 37, 48, 51, 54x2, 55	2	
E4	Rear plate	1	*7, 30, 261, 262, 265, 266, 270, 271x2, 285, 286, 223	2	
E5	Front segment	1	*9, 11, 12, 13, 14, 17, 20, 23, 25, 42x2, 53	2	
E6	Rear segment	1	*10, 16x3, 18, 19, 21, 24	2	
E7	Click lever	1	*34, 33, 35, 47	2	



No. of Subassembly	Name	Pcs. per Unit	No. of Constituent Parts (*: Main parts)	Ref. Fig. No.	Remarks
20FD11-E8	F-bracket	1	*39, 38, 40, 41, 49	2	
E9	F-gear	1	*46, 44, 45	2	
E10	Pantograph	1	*58, 57, 59, 60, 61x3, 62 63	2	
E11	Max. aperture ratchet	1	*66, 64, 65, 79, 88	2	
E12	Link A	1	*268, 273x2	2	
E13	Link B	1	*269, 273x2	2	
F1	Printed circuit	1	*210, 82x2, 86, 87, 93, 94 132x4, 165a, 165d, 170 209x2, 212x3, 237x4, 259	5,6	
F2-1	Printed switch	1	*164-1, 160-1x2, 161-1 162-1, 165b, 165c, 167, 168	3	
H1	Common contact	1	*122, 146, 207	3	
H2	Brush	1	*148, 155, 156, 157, 158x2 159	3	
H3	Roller base plate and brush gear	1	*291, H5 - H7, 147x2, 151-1 253x4, 254x2, 293x2, 294x2 298x2	3	
H4	Switch button	1	*175, 176	1	
H5	Resistor gear	1	*150, 153	3	
H6	Roller base plate	1	*291, 295x2	3	
H7	Roller adjusting plate	1	*292, 296, 297x2, 299	3	
H8	Meter	1	*187, 178, 179	3,6	
M1	Eyepiece lens case	1	*191, 191A	5	
M2	Release lever	1	*274, 280	1	
T1	T-film	1	*114, 104, 106, 107	3	
T2	T-drum	1	*128, T3, 117	4	
T3	T-film pulley	1	*111, 115	3	
T4	T-bottom cover	1	*121, 136	4	
T5	Ratchet plate	1	*123, 141, 142, 145	4	
T6	ASA dial knob	1	*124, 125, 131, 138, 139	4	
T7	Shutter speed dial	1	*130, 137	4	

No. of Subassembly	Name	Pcs. per Unit	No. of Constituent Parts (*: Main parts)	Ref. Fig. No.	Remarks
20FD11-E8	F-bracket	1	*39, 38, 40, 41, 49	2	
E9	F-gear	1	*46, 44, 45	2	
E10	Pantograph	1	*58, 57, 59, 60, 61x3, 62, 63	2	
E11	Max. aperture ratchet	1	*66, 64, 65, 79, 88	2	
E12	Link A	1	*268, 273x2	2	
E13	Link B	1	*269, 273x2	2	
F1	Printed circuit	1	*210, 82x2, 86, 87, 93, 94, 132x4, 165a, 165d, 170, 209x2, 212x3, 237x4, 259	5,6	
F2-1	Printed switch	1	*164-1, 160-1x2, 161-1, 162-1, 165b, 165c, 167, 168	3	
H1	Common contact	1	*122, 146, 207	3	
H2	Brush	1	*148, 155, 156, 157, 158x2, 159	3	
H3	Roller base plate and brush gear	1	*291, H5 - H7, 147x2, 151-1, 253x4, 254x2, 293x2, 294x2, 298x2	3	
H4	Switch button	1	*175, 176	1	
H5	Resistor gear	1	*150, 153	3	
H6	Roller base plate	1	*291, 295x2	3	
H7	Roller adjusting plate	1	*292, 296, 297x2, 299	3	
H8	Meter	1	*187, 178, 179	3,6	
M1	Eyepiece lens case	1	*191, 191A	5	
M2	Release lever	1	*274, 280	1	
T1	T-film	1	*114, 104, 106, 107	3	
T2	T-drum	1	*128, T3, 117	4	
T3	T-film pulley	1	*111, 115	3	
T4	T-bottom cover	1	*121, 136	4	
T5	Ratchet plate	1	*123, 141, 142, 145	4	
T6	ASA dial knob	1	*124, 125, 131, 138, 139	4	
T7	Shutter speed dial	1	*130, 137	4	
Δ H2-1	Brush	1	*148, 154-1, 155-1, 156, 157, 158x2, 159	3	

Revision-1 Δx 1